

**BOTÕES DE ACIONAMENTO**



**MICROCONTROLADOR ARDUINO**



**DRIVER PONTE H**

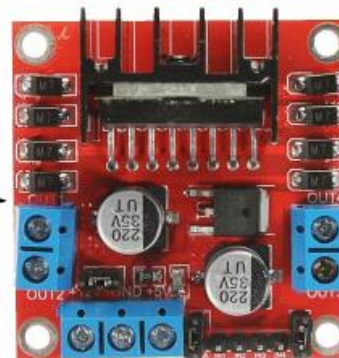

**MOTOR DC**



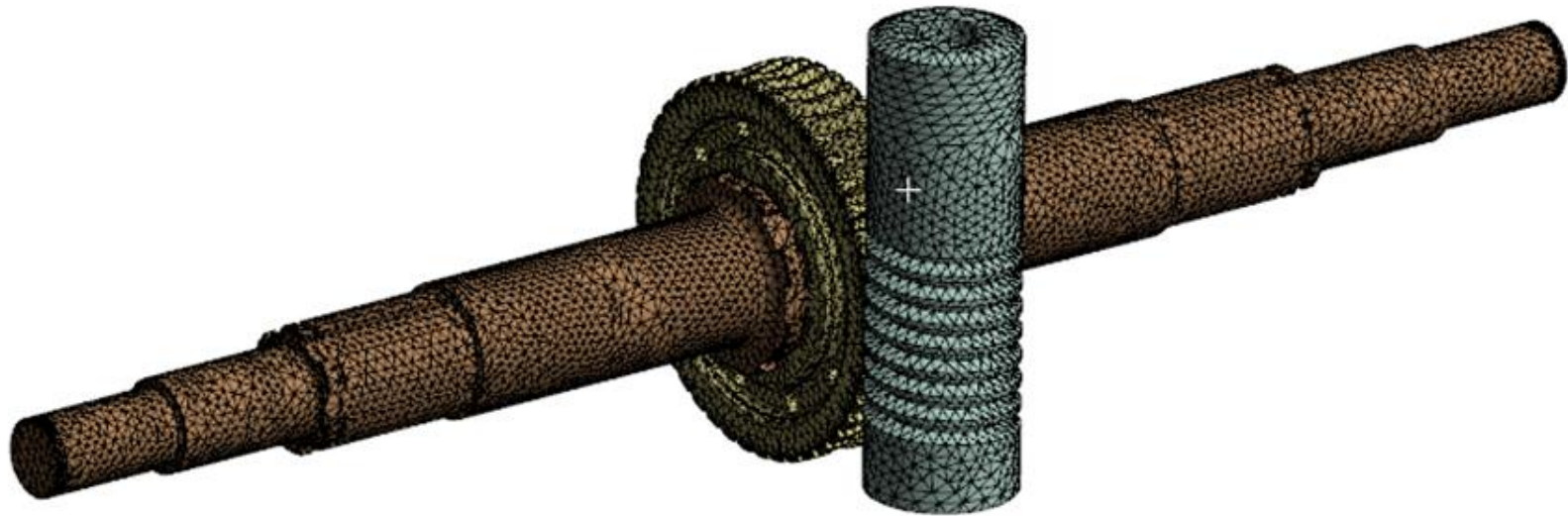

**B: Static Structural**

Static Structural

Time: 1, s

- A** Moment: 3070, N-mm
- B** Remote Displacement
- C** Fixed Support

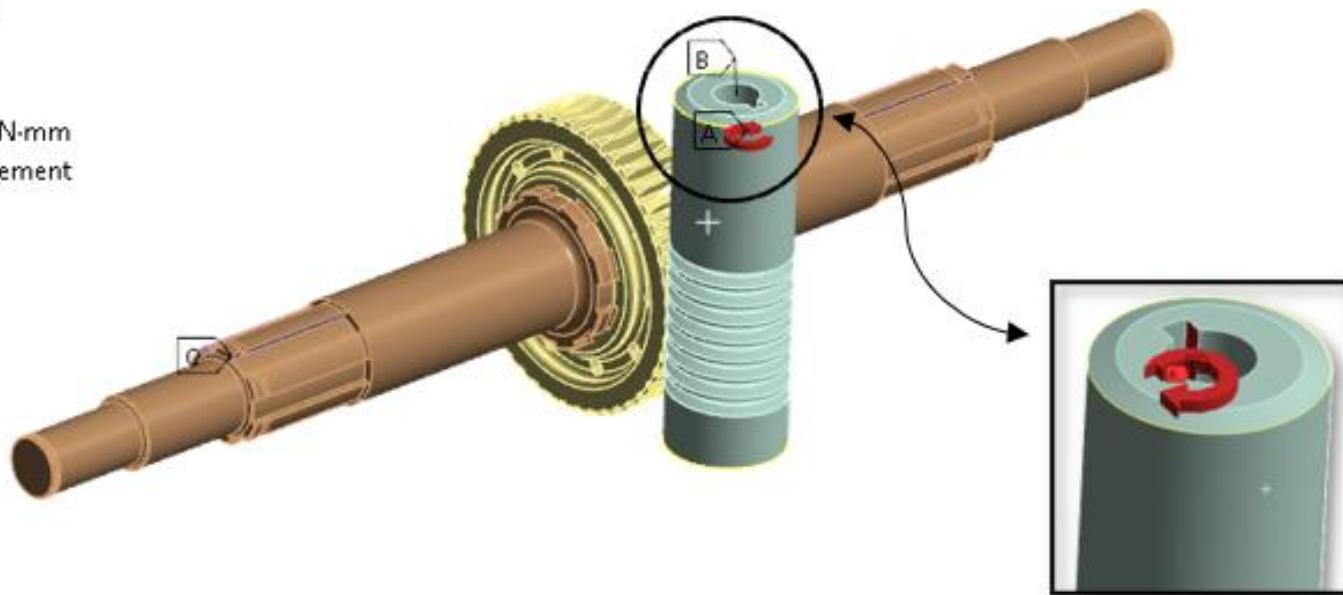

**B: Static Structural**

Coroa

Type: Equivalent (von-Mises) Stress

Unit: MPa

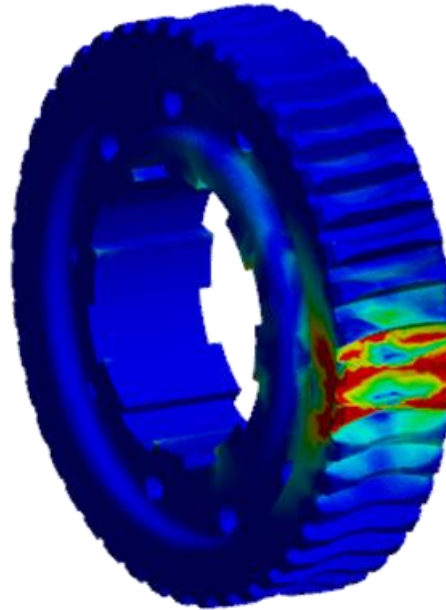
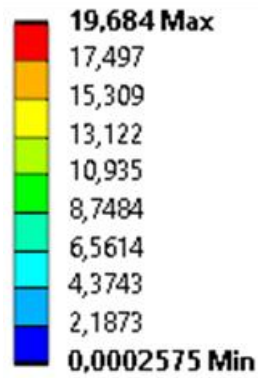

**B: Static Structural**

Shear Stress

Type: Shear Stress(XY Component)

Unit: MPa

Global Coordinate System

Time: 1

11/29/2020 3:11 PM

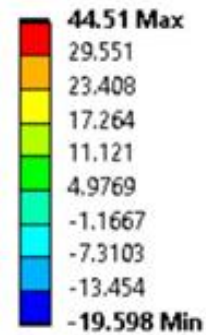

**A: Static Structural**

Equivalent Stress

Type: Equivalent (von-Mises) Stress

Unit: MPa

Time: 1

07/12/2020 07:07

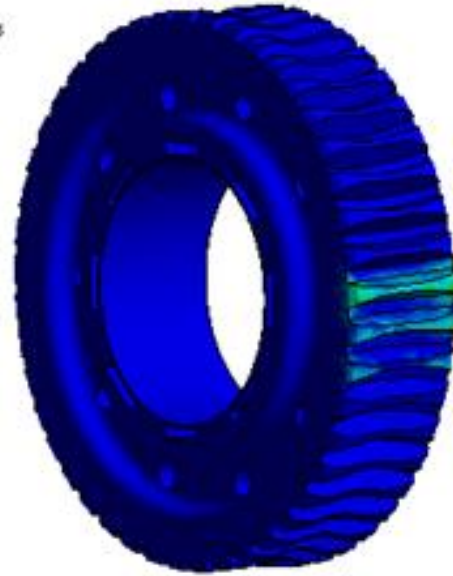
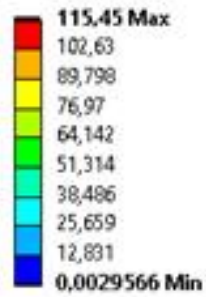

**A: Static Structural**

Shear Stress

Type: Shear Stress(XY Plane)

Unit: MPa

Global Coordinate System

Time: 1

07/12/2020 07:07

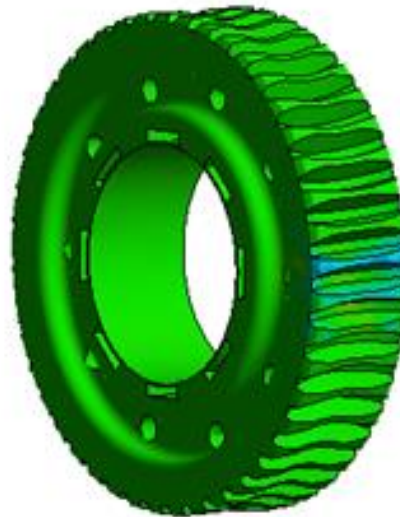
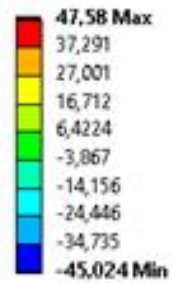



**B: Static Structural**

Eixo Motor

Type: Equivalent (von-Mises) Stress

Unit: MPa

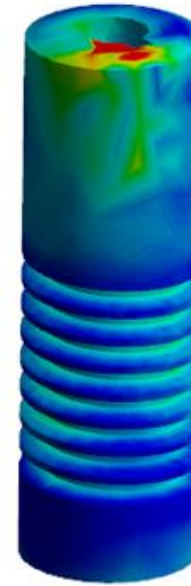
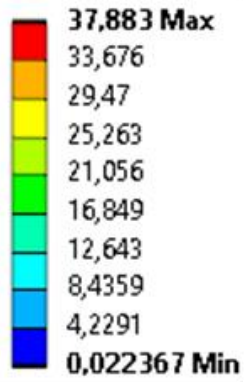

**B: Static Structural**

Eixo Motor

Type: Shear Stress(XY Component)

Unit: MPa

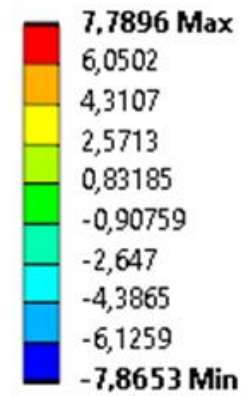

**A: Static Structural**

Equivalent Stress

Type: Equivalent (von-Mises) Stress

Unit: MPa

Time: 1

07/12/2020 06:55

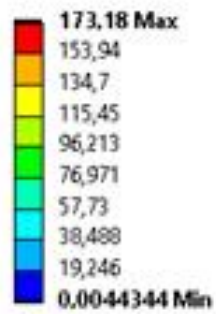

**A: Static Structural**

Shear Stress

Type: Shear Stress(OY Plane)

Unit: MPa

Global Coordinate System

Time: 1

07/12/2020 06:56

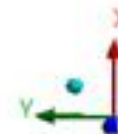
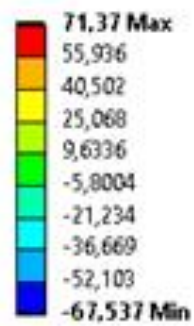

**A: Static Structural**

Remote Force  
Time: 1, s  
07/12/2020 20:28

Remote Force: 780, N  
Components: 0,;0,;780, N  
Location: -0,20374, 1,0984e-007, -1,9624e-020 m

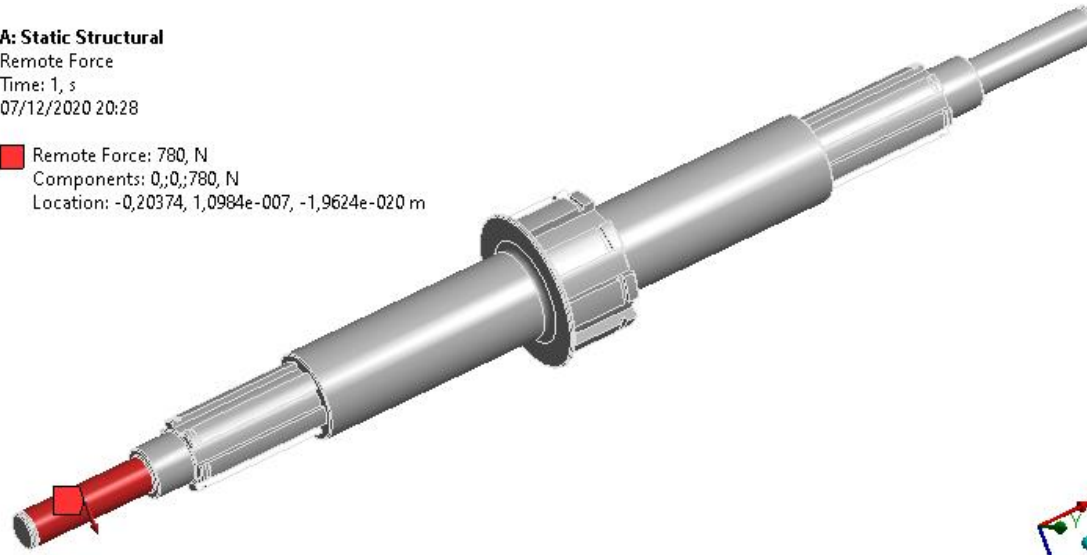

**A: Static Structural**

Equivalent Stress  
Type: Equivalent (von-Mises) Stress  
Unit: MPa  
Time: 1  
07/12/2020 20:30

136,13 Max  
121,01  
105,88  
90,754  
75,628  
60,503  
45,377  
30,251  
15,126  
8,6452e-12 Min

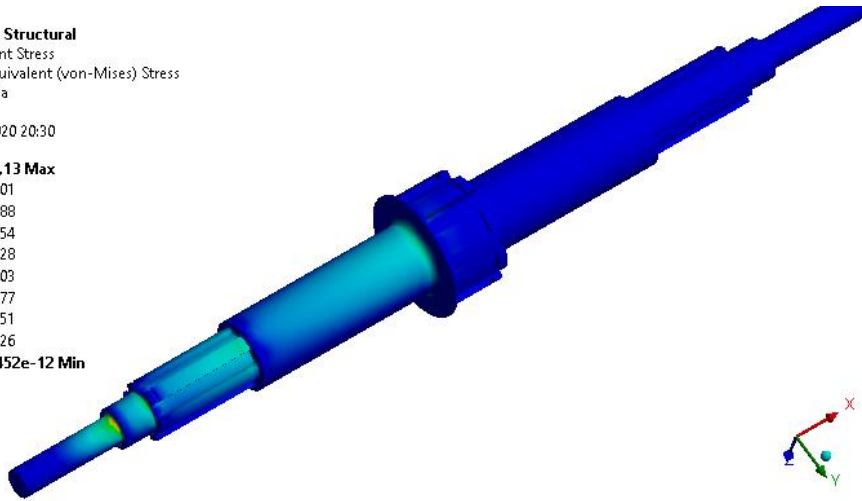

**A: Static Structural**

Maximum Shear Stress  
Type: Maximum Shear Stress  
Unit: MPa  
Time: 1  
07/12/2020 20:31

74,399 Max  
66,132  
57,866  
49,599  
41,333  
33,066  
24,8  
16,533  
8,2666  
4,9882e-12 Min

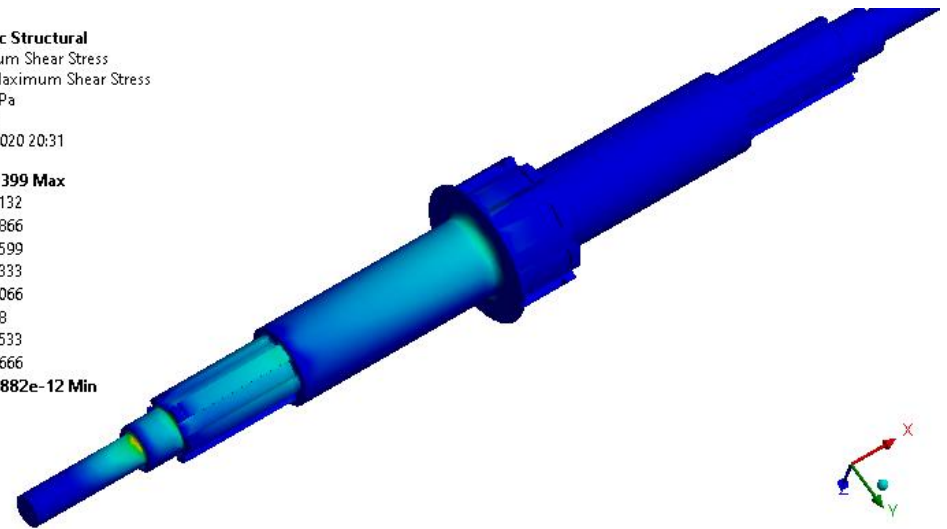

**A: Static Structural**

Moment

Time: 1, s

07/12/2020 20:22

**A** Remote Force: 780, N

**B** Moment: 331,7 N·m

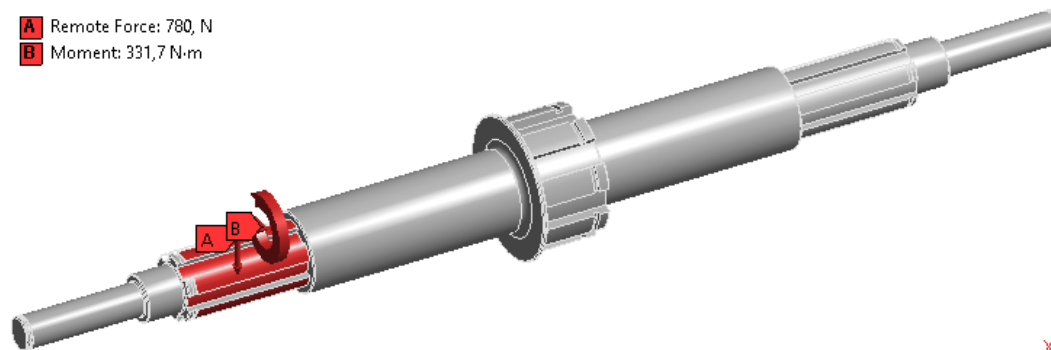

**A: Static Structural**

Equivalent Stress

Type: Equivalent (von-Mises) Stress

Unit: MPa

Time: 1

07/12/2020 20:15

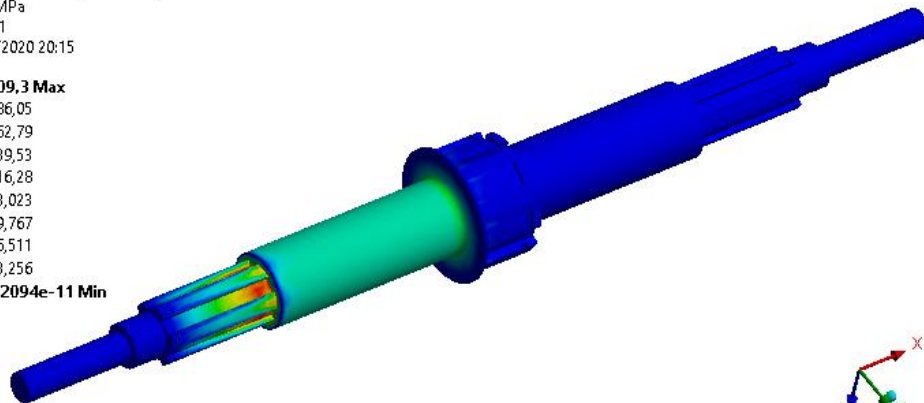
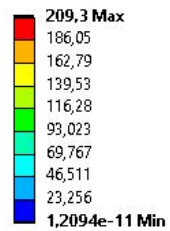

**A: Static Structural**

Maximum Shear Stress

Type: Maximum Shear Stress

Unit: MPa

Time: 1

07/12/2020 20:21

